

SPECIFICATION							
1	Model No.		EMC6035				
2	ITEM	Symbol	Test Conditions	Min	Standard	Max	Unit
3	Sensitivity	S	f=1KHz,	-39	-35	-31	dB
4			S.P.L=1μBar				
5	Impedance	Z	f=1KHz,			2.2	KΩ
6			S.P.L=1μBar				
7	Directivity	Omni-directional					
8	Current Consumption	I		50	500		μA
9	Operation Voltage Range	VS		1	2	10	V
10	S/N Ratio	S/N(A)	f=1KHz, S.P.L=1Pa	60			dB
11			A Curve				
12	Decreasing Voltage Characteristic	ΔS	f=1KHz,S.P.L=1μBar			-3	dB
13			VS=2.0-1.5V				
14	Max.Input Sound Level	MISPL	f=1KHz,			110	dB
15			Distortion≤3%				

f=1KHz,S.P.L=1μBar,VS=4.5-3.0V,Distortion<1%

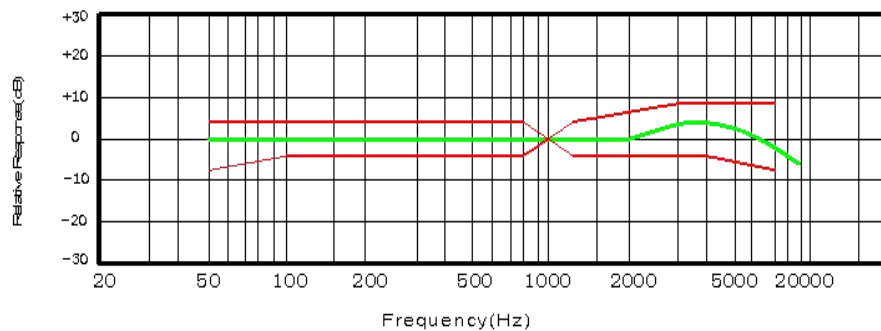

NOTES:

- 1.ALL DIMENSIONS ARE IN MILLIMETERS
- 2.SPECIFICATIONS SUBJECT TO CHANGE WITHOUT NOTICE

REVISION HISTORY			
LTR	DESCRIPTION	DATE	APPROVED
-	RELEASED FROM ENGINEERING	9/23/2003	Y M
-	RELEASED FROM ENGINEERING	9/23/2003	Y M
A			
B			
C			

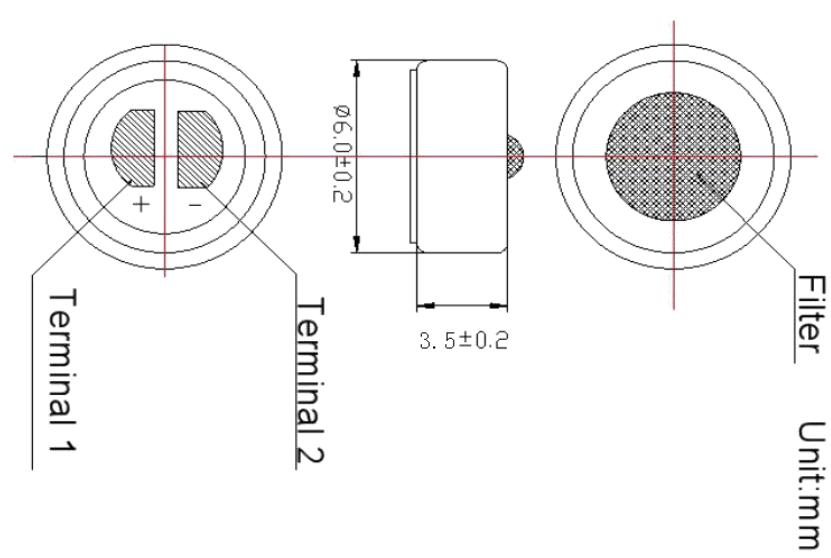
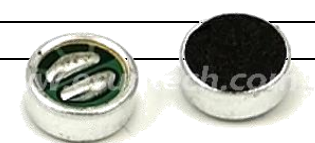

UNLESS OTHERWISE SPECIFIED. DIMENSIONS ARE IN MILLIMETERS TOLERANCES ARE +/-0.5 AND ANGLES ARE +/-3°	SIZE	Designed by	Date	Checked by	Date	Approved by	Date	Drawed date
	A4			EMC6035				
	EMC6035			http://www.esuntech.com.cn	C/MIC	Edition		