

SPECIFICATION		
1	Model No.	EPB2395W1303-TA-12-3.4-R
2	Rated Voltage (VDC)	12
3	Operating Voltage (VDC)	3~20
4	*Rated Current (mA)	≤15
5	*Sound Output at 10 cm (dB)	≥90
6	*Resonant Frequency (Hz)	3400±500
7	Lead Wire	UL1007AWG28
8	Operating Temperature (°C)	-20 ~ +65
9	Storage Temperature (°C)	-30 ~ +75
10	Weight (g)	4
11	Housing Material	ABS
	RoHS	Yes

THIS DOCUMENT CONTAINS DATE PROPRIETARY TO PROJECTS CHANGZHOU ESUNTECH CO LTD. ANY USE OR REPRODUCTION, IN ANY FORM, WITHOUT PRIOR WRITTEN PERMISSION OF PROJECTS CHANGZHOU ESUNTECH CO LTD IS PROHIBITED.  
©2003, Project Changzhou Esuntech Co Ltd

REVISION HISTORY			
LTR	DESCRIPTION	DATE	APPROVED
-	RELEASED FROM ENGINEERING	9/23/2003	Y M
A			
B			
C			

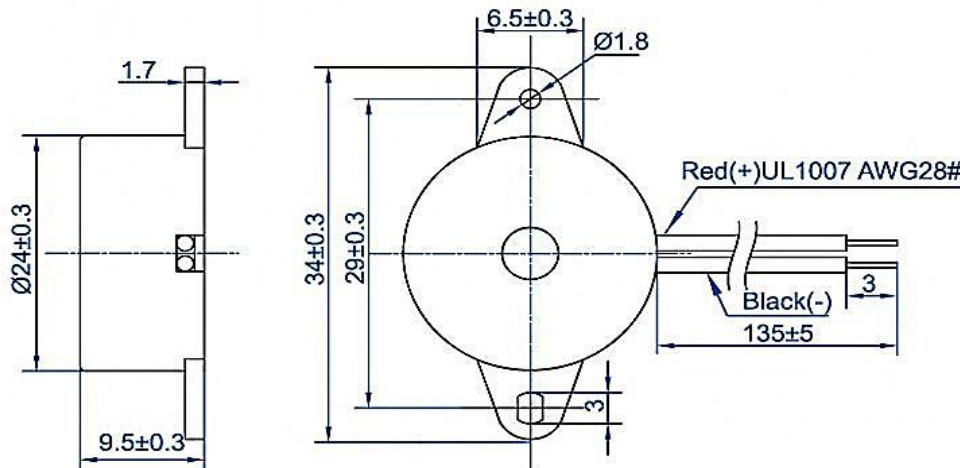
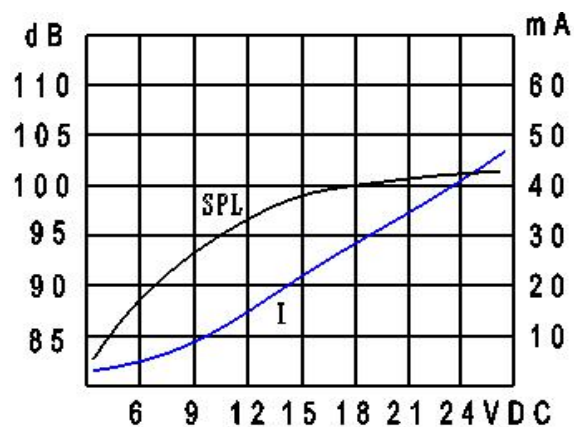

NOTES:

1. ALL DIMENSIONS ARE IN MILLIMETERS
2. SPECIFICATIONS SUBJECT TO CHANGE WITHOUT NOTICE

SIZE	Designed by	Date	Checked by	Date	Approved by	Date	Drawed date
A4	 Changzhou Esuntech Co.,Ltd <a href="http://www.esuntech.com.cn">http://www.esuntech.com.cn</a>		EPB2395W1303-TA-12-3.4-R		BUZZER	Edition	Sheet